

Lot 2



Glen Estate

64-66 GLEN RD, STOKES VALLEY

Lot 2



Lot 2



Lot 2



Lot 2

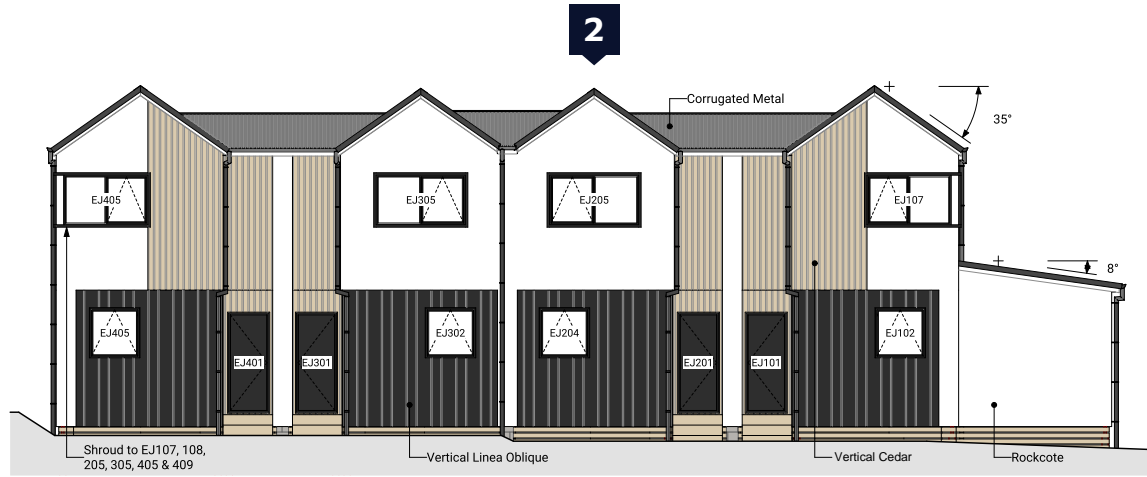

1 North East Elevation

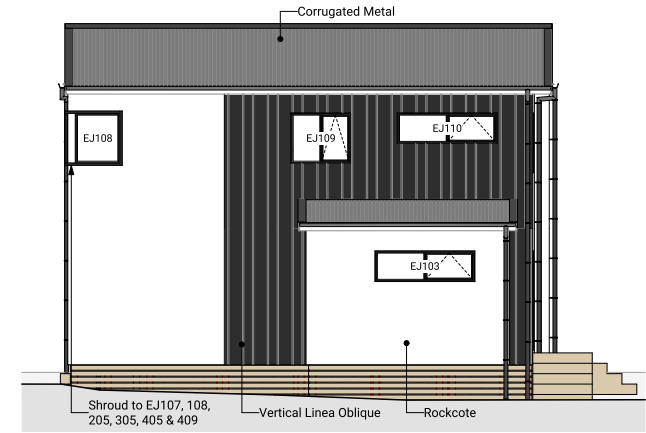

2 North West Elevation

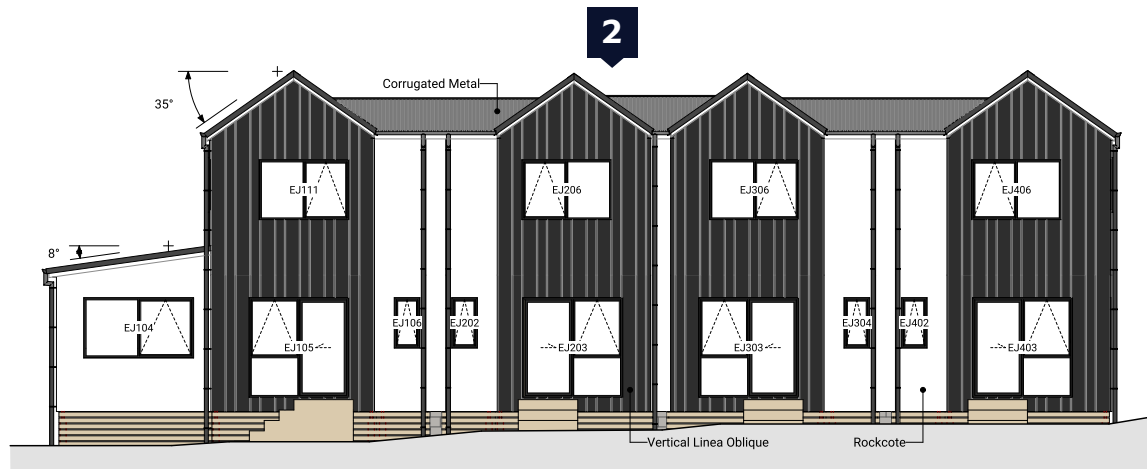

3 South West Elevation

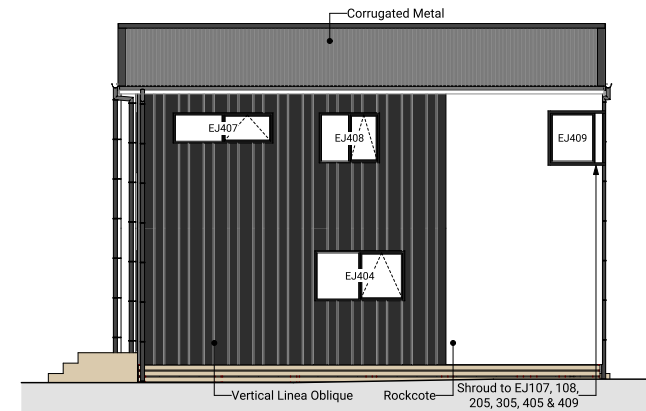

4 South East Elevation

Lot 2

Lower Floor Area	38.47m ²
Upper Floor Area	41.40m ²
Total Floor Area	79.87m ²

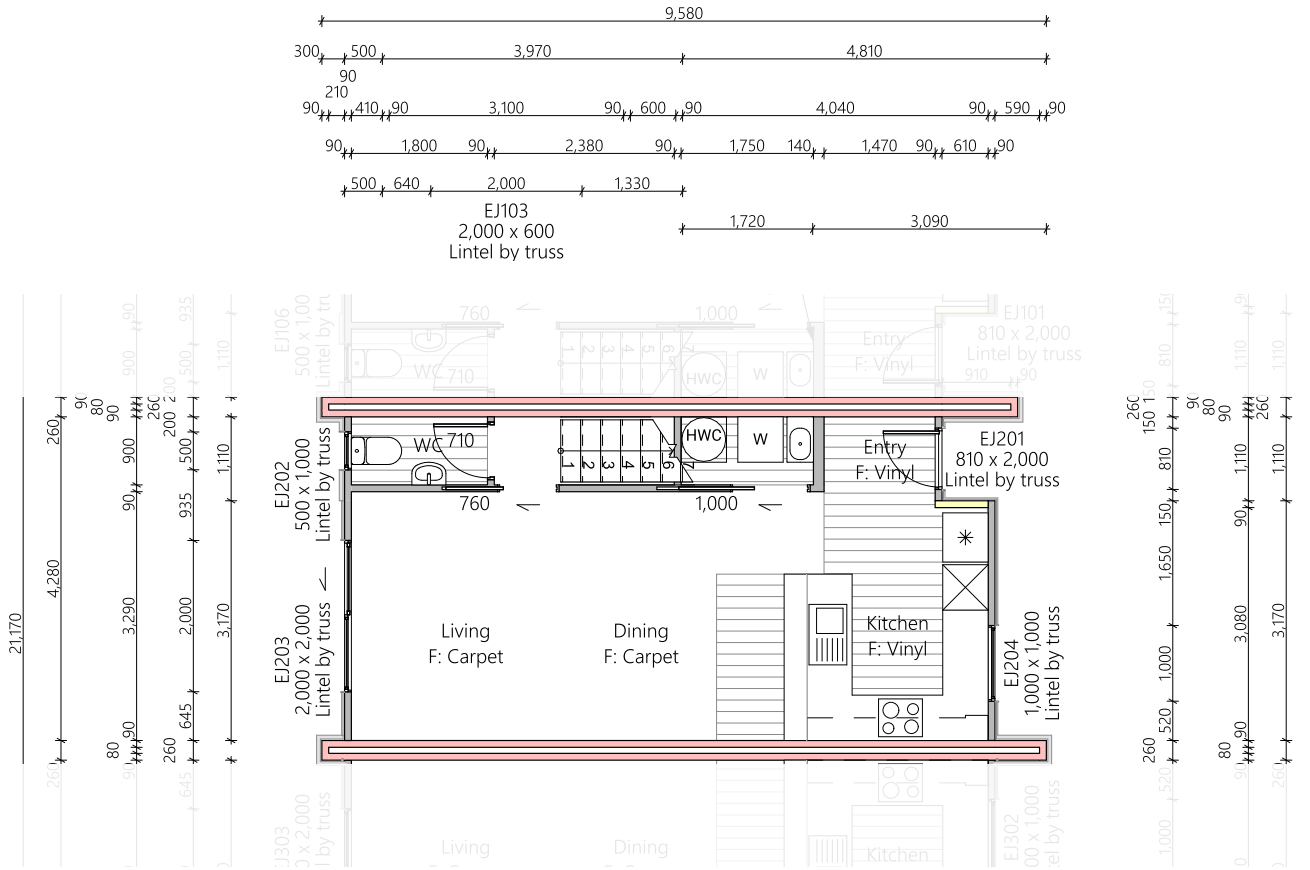

Lot 2

Lower Floor Area	38.47m ²
Upper Floor Area	41.40m ²
Total Floor Area	79.87m ²

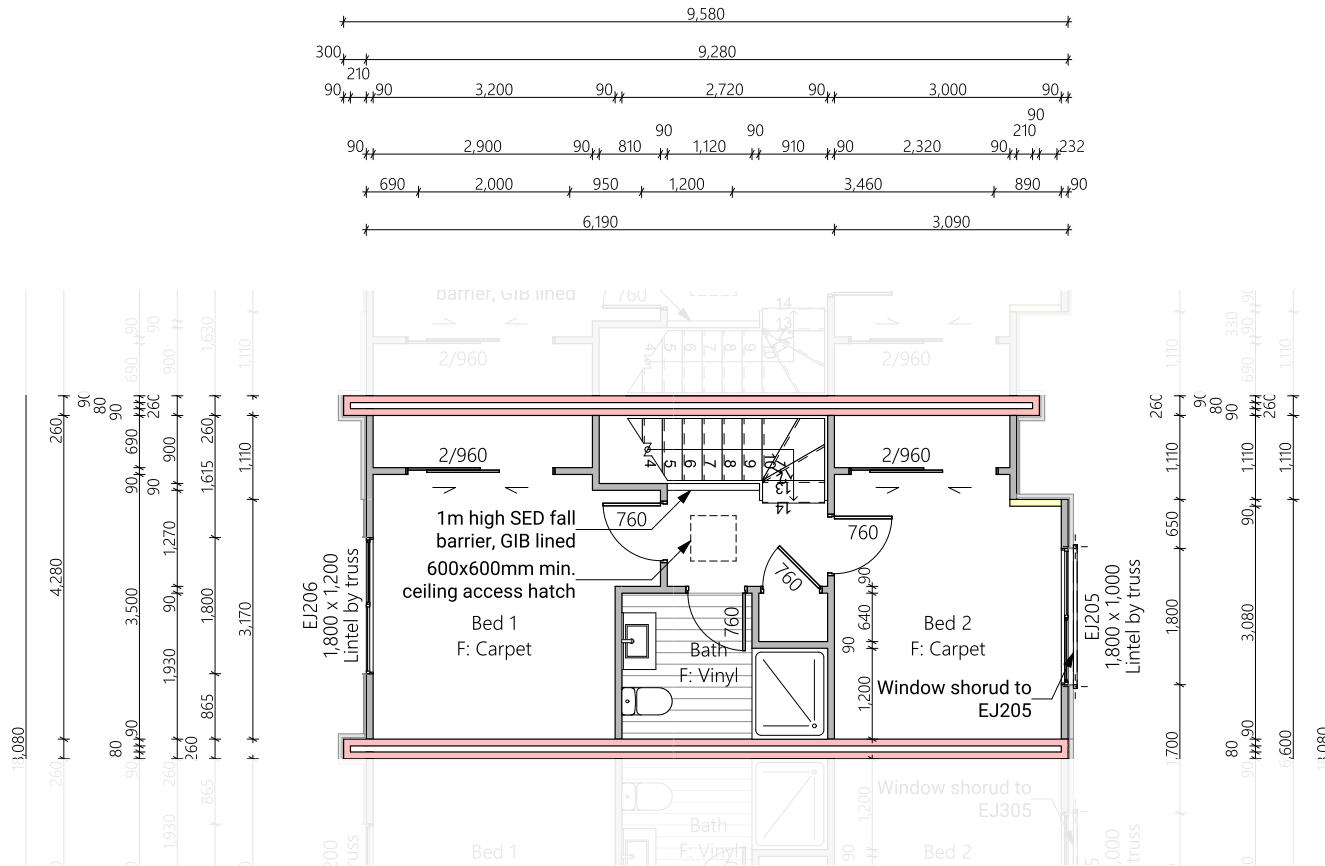

Lot 2

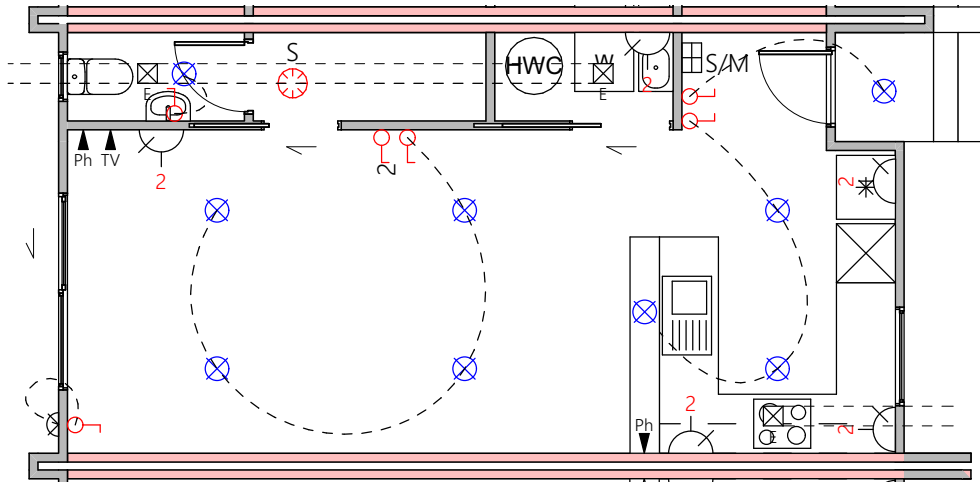

Lower Electrical Plan

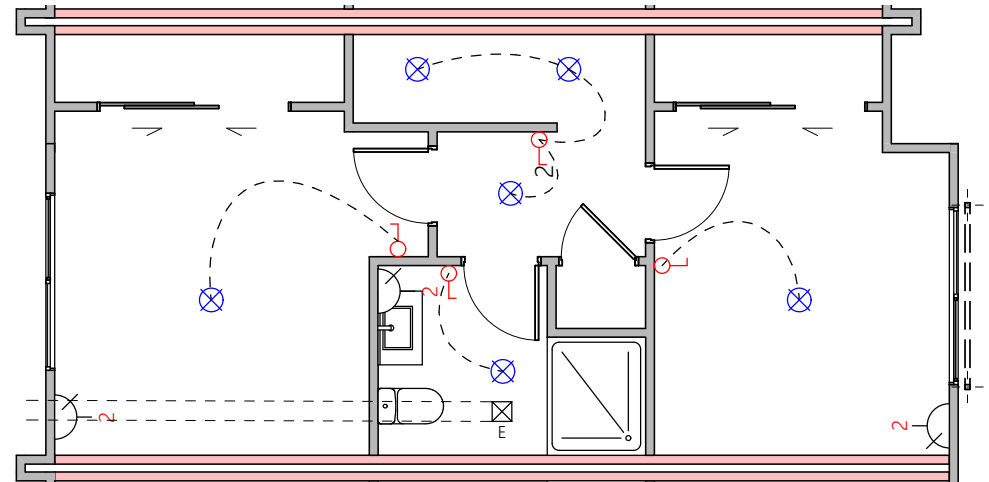

Upper Electrical Plan

S/M	Smart Meter	P	Power point	L	Light switch
G	Garage door motor	Ph	Phone outlet	2-L	Two way light switch
S	Smoke detector	TV	Television outlet	⊗	Recessed downlight
F	Extractor fan				

Lot 2

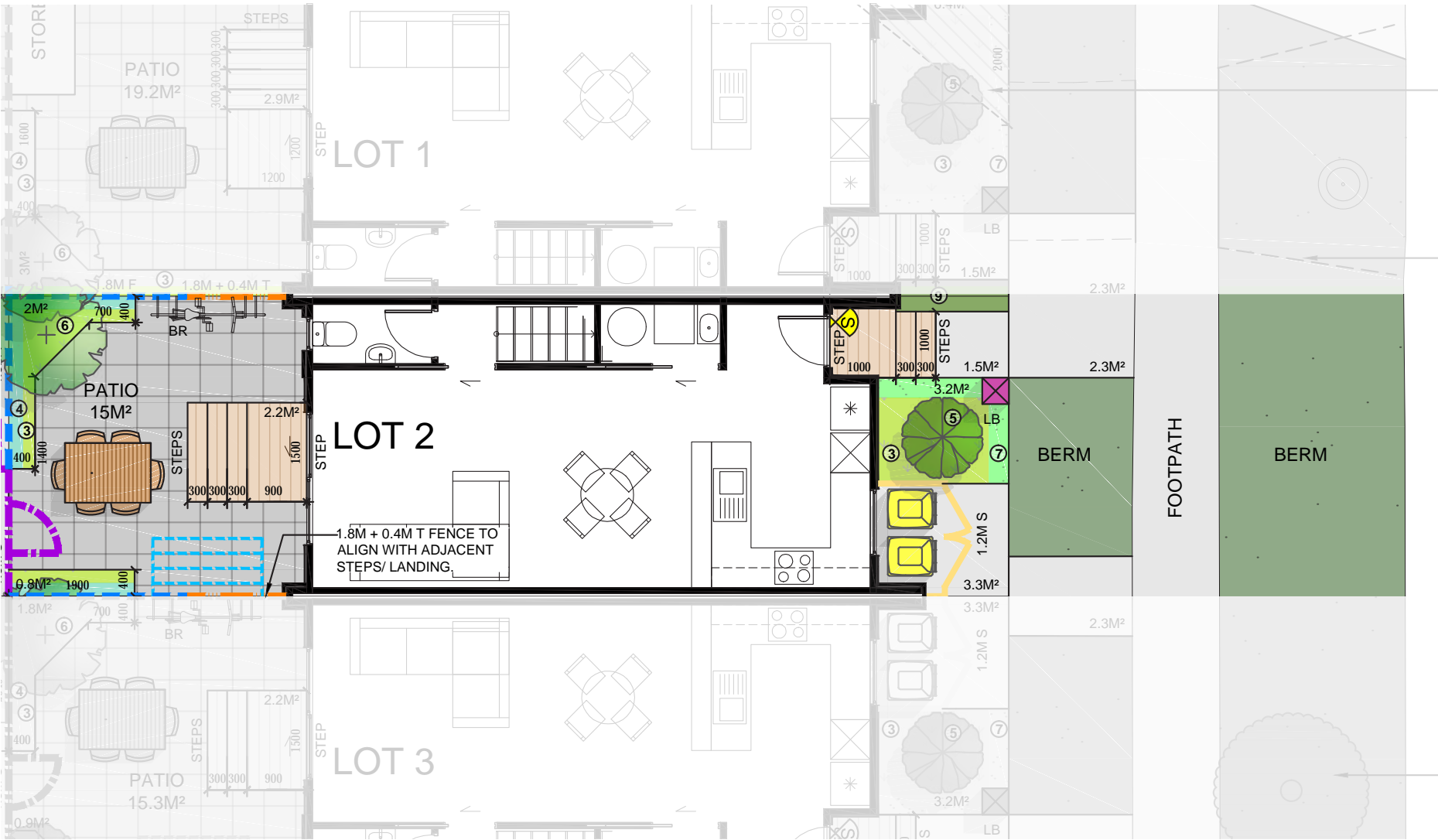

Lot 2

	Product	Colour/Finish
EXTERIOR LOT 2		
Roof	Colorsteel Corrugated	Flaxpod
Fascia/Barge Boards	Colorsteel	Flaxpod
Spouting	Colorsteel	Flaxpod
Downpipes	Colorsteel Marley PVC Colour (if retention tank)	Flaxpod OR Ironsand
Retention Tank (if required)	Thin Tanks NZ	Monument
Soffits/Eaves	Painted	Wattyl Men In Black
Cladding 1	Linea Oblique – vertical (painted)	Wattyl Men In Black
Cladding 2	Rockcote Plaster (painted)	Resene Half Foggy Grey
Cladding 3	Cedar – vertical (stained)	Wattyl Forestwood (Iron Bark)
Concrete Letterbox	Painted	Wattyl Enclose Half
Aluminium Joinery (with clear glass)	Powdercoated	Flaxpod
(Residential Hardware to all aluminium joinery is colour matched to joinery)		
Front Door	Vertical Groove	Flaxpod
Front Door Handle	Residential Lever Hardware	Powdercoat finish matched to door

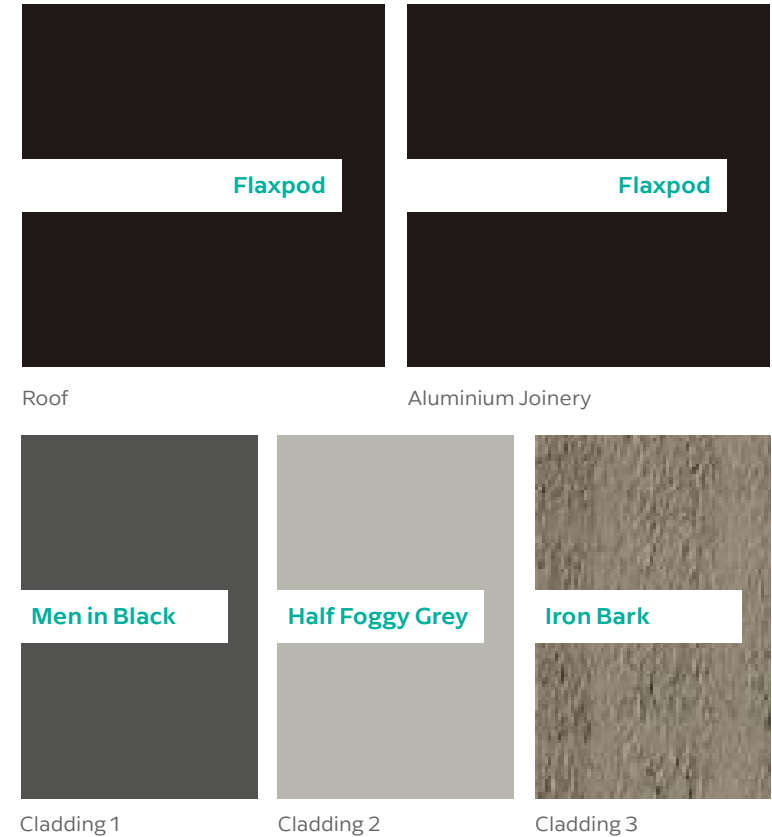

All colour swatches are indicative only